

65V N-Ch Power MOSFET
Feature

- ◇ High Speed Power Switching
- ◇ Enhanced Body diode dv/dt capability
- ◇ Enhanced Avalanche Ruggedness
- ◇ 100% UIS Tested, 100% Rg Tested
- ◇ Lead Free, Halogen Free

V_{DS}		65	V
$R_{DS(on),typ}$	$V_{GS}=10V$	4.5	m Ω
I_D (Silicon Limited)		66	A

Application

- ◇ Synchronous Rectification in SMPS
- ◇ Hard Switching and High Speed Circuit
- ◇ DC/DC in Telecoms and Industrial

DFN3.3*3.3

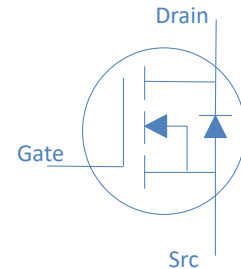
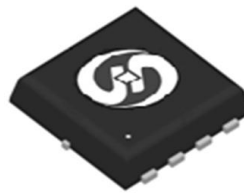

Part Number	Package	Marking
HGM046NE6A	DFN 3.3*3.3	GM046NE6A

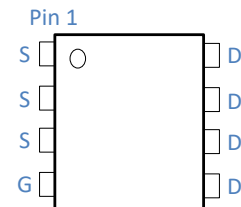
Absolute Maximum Ratings at $T_J=25^\circ\text{C}$ (unless otherwise specified)

Parameter	Symbol	Conditions	Value	Unit
Continuous Drain Current (Silicon Limited)	I_D	$T_C=25^\circ\text{C}$	66	A
		$T_C=100^\circ\text{C}$	42	
		$T_C=25^\circ\text{C}$	36	
Continuous Drain Current (Package Limited)		$T_C=25^\circ\text{C}$	36	
Drain to Source Voltage	V_{DS}	-	65	V
Gate to Source Voltage	V_{GS}	-	± 20	V
Pulsed Drain Current	I_{DM}	-	340	A
Avalanche Energy, Single Pulse	E_{AS}	$L=0.1\text{mH}, T_C=25^\circ\text{C}$	31	mJ
Power Dissipation	P_D	$T_C=25^\circ\text{C}$	42	W
Operating and Storage Temperature	T_J, T_{stg}	-	-55 to 150	$^\circ\text{C}$

Absolute Maximum Ratings

Parameter	Symbol	Max	Unit
Thermal Resistance Junction-Ambient	$R_{\theta JA}$	50	$^\circ\text{C/W}$
Thermal Resistance Junction-Case	$R_{\theta JC}$	3	$^\circ\text{C/W}$

Electrical Characteristics at $T_j=25^\circ\text{C}$ (unless otherwise specified)
Static Characteristics

Parameter	Symbol	Conditions	Value			Unit
			min	typ	max	
Drain to Source Breakdown Voltage	$V_{(BR)DSS}$	$V_{GS}=0V, I_D=250\mu A$	65	-	-	V
Gate Threshold Voltage	$V_{GS(th)}$	$V_{GS}=V_{DS}, I_D=250\mu A$	2.0	2.7	4.0	
Zero Gate Voltage Drain Current	I_{DSS}	$V_{GS}=0V, V_{DS}=60V, T_j=25^\circ\text{C}$	-	-	1	μA
		$V_{GS}=0V, V_{DS}=60V, T_j=100^\circ\text{C}$	-	-	100	
Gate to Source Leakage Current	I_{GSS}	$V_{GS}=\pm 20V, V_{DS}=0V$	-	-	± 100	nA
Drain to Source on Resistance	$R_{DS(on)}$	$V_{GS}=10V, I_D=20A$	-	4.5	5.2	$m\Omega$
Transconductance	g_{fs}	$V_{DS}=5V, I_D=20A$	-	50	-	S
Gate Resistance	R_G	$V_{GS}=0V, V_{DS}$ Open, $f=1\text{MHz}$	-	1.2	-	Ω

Dynamic Characteristics

Input Capacitance	C_{iss}	$V_{GS}=0V, V_{DS}=30V, f=1\text{MHz}$	-	2373	-	pF
Output Capacitance	C_{oss}		-	769	-	
Reverse Transfer Capacitance	C_{rss}		-	45	-	
Total Gate Charge	$Q_g(10V)$	$V_{DD}=30V, I_D=20A, V_{GS}=10V$	-	41	-	nC
Gate to Source Charge	Q_{gs}		-	10	-	
Gate to Drain (Miller) Charge	Q_{gd}		-	10	-	
Turn on Delay Time	$t_{d(on)}$	$V_{DD}=30V, I_D=20A, V_{GS}=10V, R_G=10\Omega,$	-	11	-	ns
Rise time	t_r		-	7	-	
Turn off Delay Time	$t_{d(off)}$		-	35	-	
Fall Time	t_f		-	9	-	

Reverse Diode Characteristics

Diode Forward Voltage	V_{SD}	$V_{GS}=0V, I_F=30A$	-	0.9	1.2	V
Reverse Recovery Time	t_{rr}	$V_R=30V, I_F=20A, di_F/dt=400A/\mu s$	-	35	-	ns
Reverse Recovery Charge	Q_{rr}		-	88	-	nC

Fig 1. Typical Output Characteristics

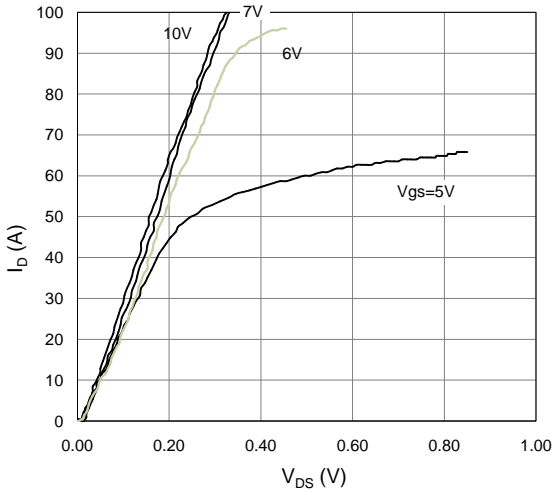

Figure 2. On-Resistance vs. Gate-Source Voltage

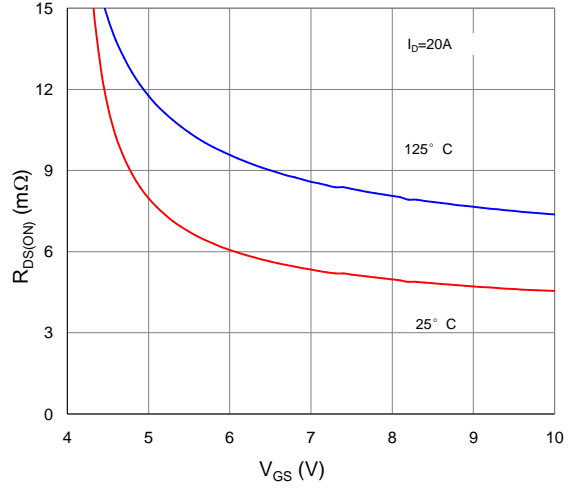

Figure 3. On-Resistance vs. Drain Current and Gate Voltage

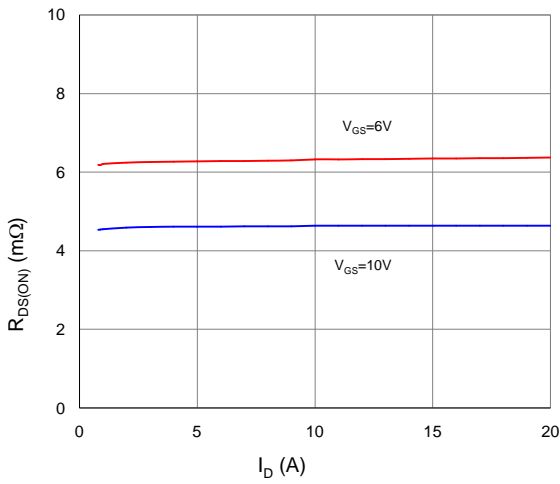

Figure 4. Normalized On-Resistance vs. Junction Temperature

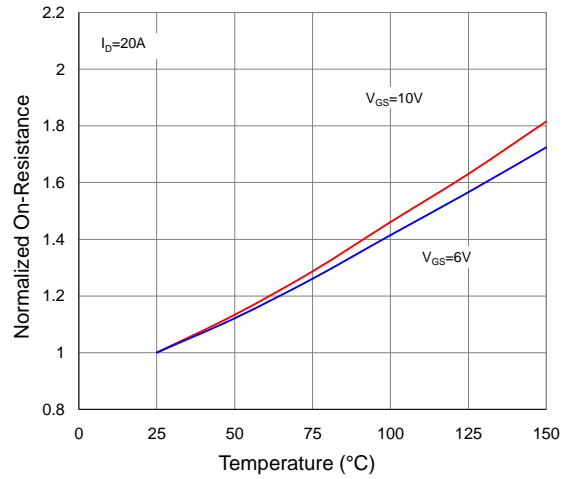

Figure 5. Typical Transfer Characteristics

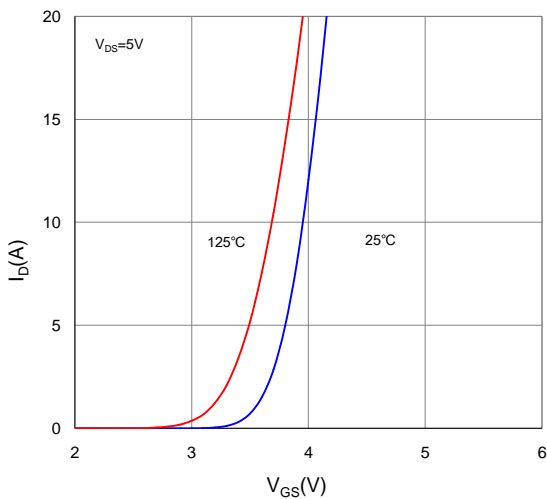

Figure 6. Typical Source-Drain Diode Forward Voltage

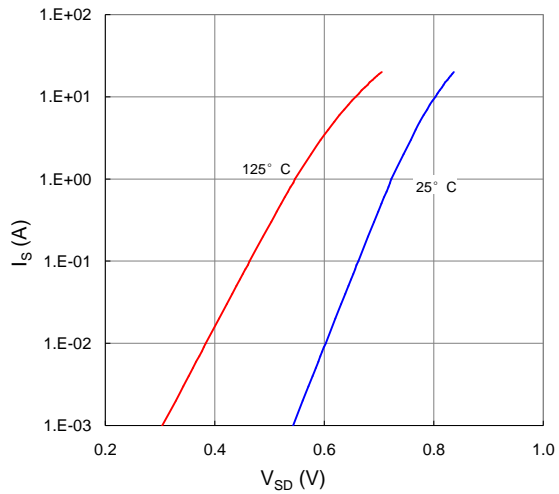

Figure 7. Typical Gate-Charge vs. Gate-to-Source Voltage

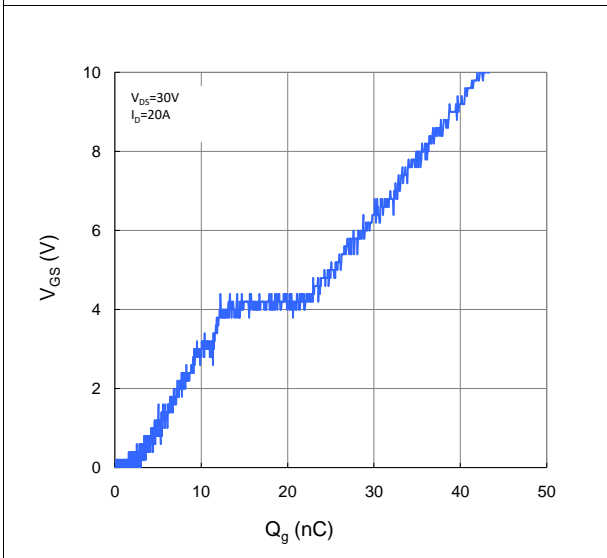

Figure 8. Typical Capacitance vs. Drain-to-Source Voltage

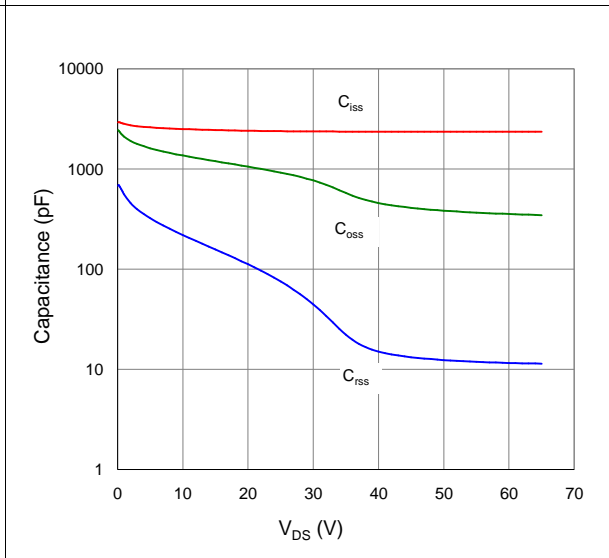

Figure 9. Maximum Safe Operating Area

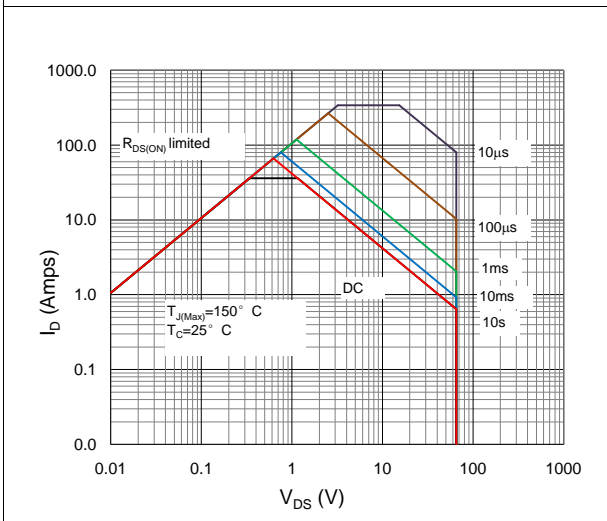

Figure 10. Maximum Drain Current vs. Case Temperature

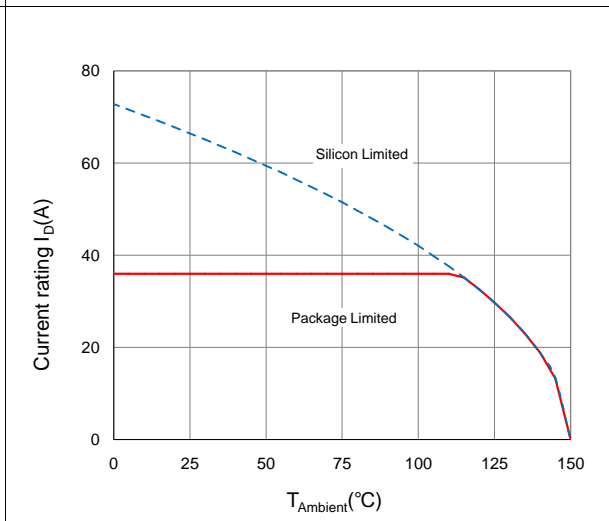
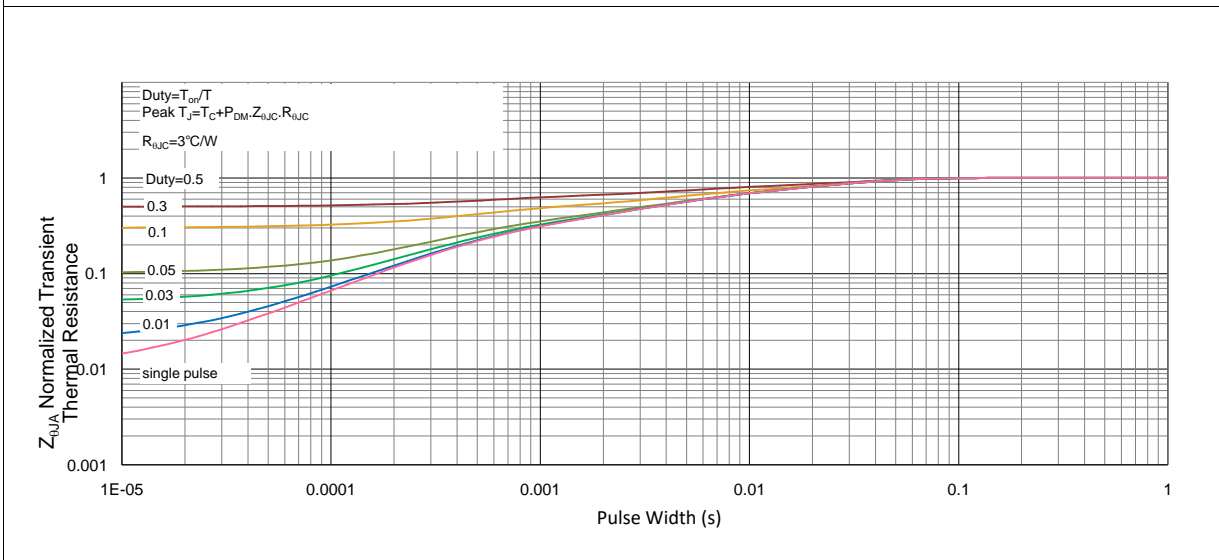
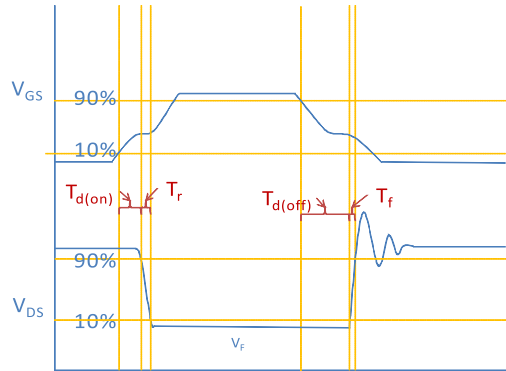
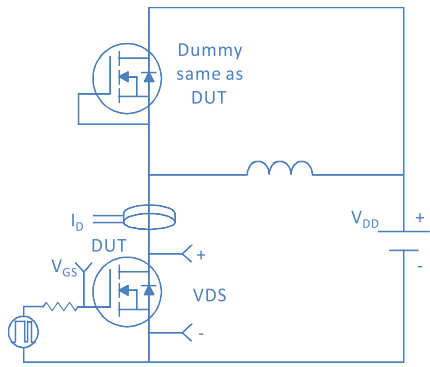

Figure 11. Normalized Maximum Transient Thermal Impedance, Junction-to-Ambient



Inductive switching Test



Gate Charge Test

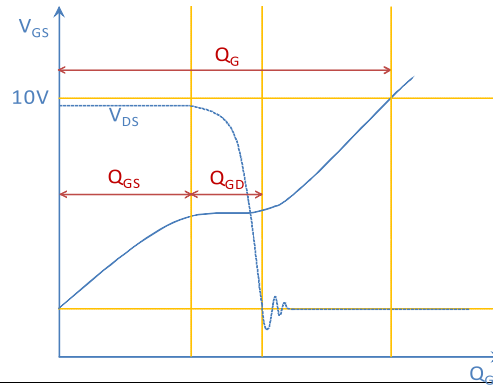
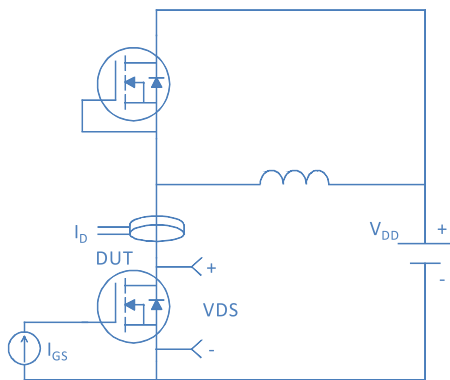

Uclamped Inductive Switching (UIS) Test

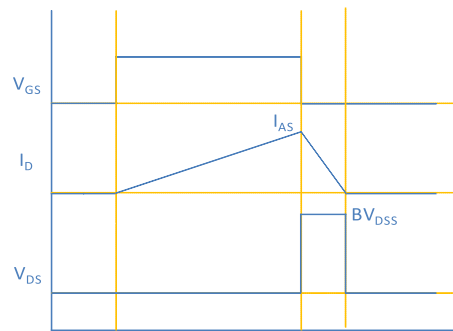
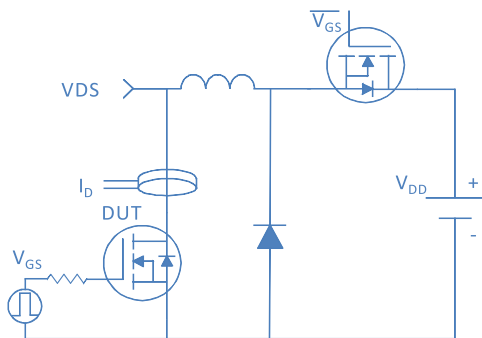

Diode Recovery Test

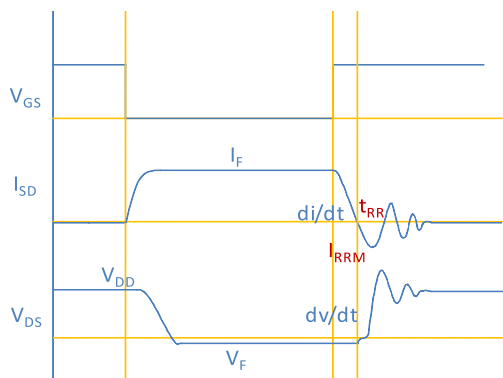
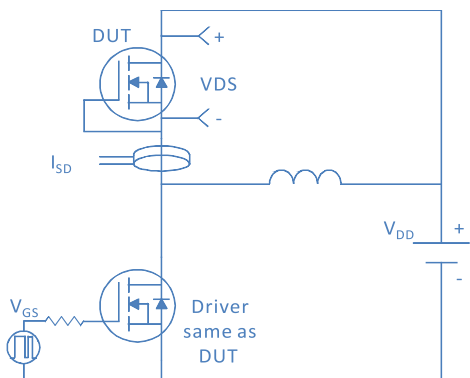

Package Outline

DFN3.3*3.3_P, 8 leads

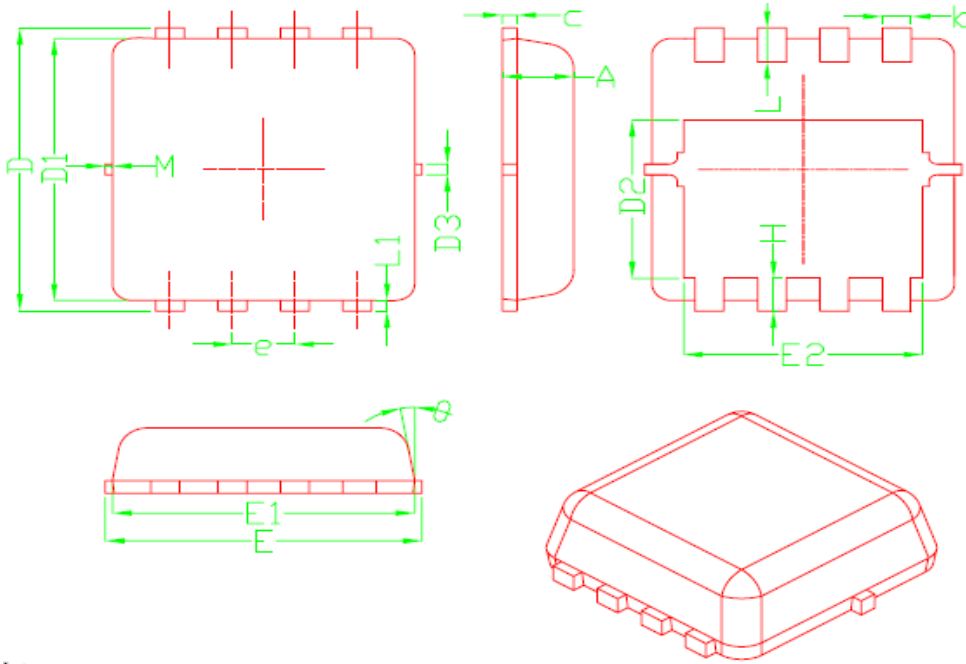

SYMBOL	DIMENSIONAL REQMTS		
	MIN	NOM	MAX
A	0.70	0.75	0.80
b	0.25	0.30	0.35
c	0.10	0.15	0.25
D	3.25	3.35	3.45
D1	3.00	3.10	3.20
D2	1.78	1.88	1.98
D3	---	0.13	---
E	3.20	3.30	3.40
E1	3.00	3.15	3.20
E2	2.39	2.49	2.59
e	0.65BSC		
H	0.30	0.39	0.50
L	0.30	0.40	0.50
L1	---	0.13	---
θ	---	10°	12°
M	*	*	0.15

* Not specified